

807





TABLE & FLOOR LAMP

Design
Sustainability
Value



Design: Randy Borden

807-TL Shown in Satin Aluminum Finish

-  print this page
-  email this page to a colleague
-  installation instructions
-  interactive submittal drawing



Dimming switch.



FEATURES

- Classic style that evokes the Bauhaus.
- Softly glowing dome provides task/ ambient light without glare.
- Table lamp available in two sizes.

MATERIALS

- Solid brass or aluminum metal work, hand finished.
- Luminous dome is white acrylic with a matte finish.
- White or black cord & plug.

FINISHES

- SAL** Satin Aluminum
- SB** Satin Brass
- AB** Antique Brass

Standard metal finishes are hand satined and either waxed or sealed with a water-based clear coat. Other metal finishes are available. Contact factory.

LAMPS

CF: For 14"Ø - One CF 26 triple twin tube 4-pin, 2700K, non-amalgam, lamp supplied with table and floor lamp. Ballast will operate 26 or 32W triple tube lamps.

Note that only 26W lamp is supplied.

12"Ø is supplied with 13W DTT lamp.

LED: 1-GU24 base A-lamp, 12W, 1100 lumens, 3000K, 80+ CRI, supplied.

BALLAST

Electronic HPF, Class P, Sound Rated A, with end-of-lamp-life circuitry and thermal protection.

ECO INFO

METALS: Aluminum and brass with the highest available recycled content for lower embodied energy. Both metals are valuable and recyclable at the end of the product's useful life. For more information see "GENERAL INFO"

FINISHING: Aluminum and Antique Brass finishes are sealed with a hand-applied bees wax. No paint or lacquer is used in order to avoid pollution associated with the manufacture and application of these substances. Satin Brass is clear-coated with a very low VOC water-based coating. Paint finishes are low VOC and oven cured.

ENERGY: Designed exclusively for compact fluorescent lamps using HPF electronic ballasts.



807-FL Shown in Satin Brass.

807-FL FLOOR LAMP

The floor lamp version exhibits the same aesthetic quality and energy efficiency as its table lamp counterpart with slightly larger dome.

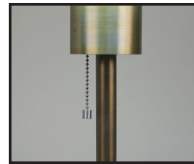
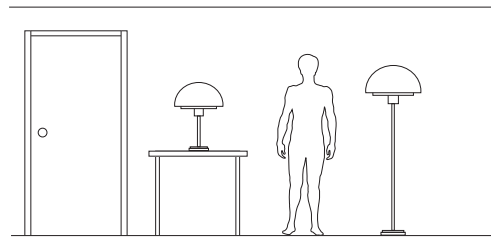
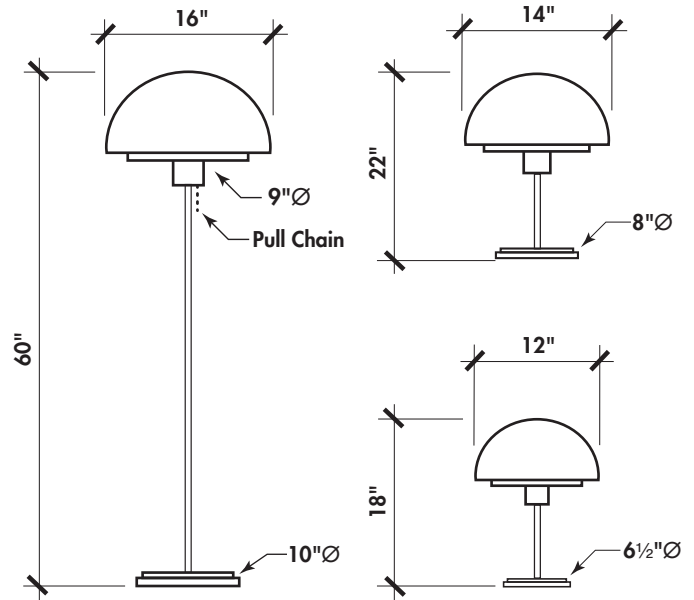

Pull chain.

OPTIONS

TABLE LAMP SIZE: Available in 14"Ø or 12"Ø.

FAUX ALABASTER: Luminous dome available with hand-applied finish. Specify **FAUX**.

DIMMING: Electronic dimming ballast with 100-15% dimming range. (See front photo.)

CORD: Two conductor cord with polarized plug available in black or white. Specify **BLK** or **WHT**.

CONVENIENCE OUTLET: Electrical power outlet integral to the base available. Specify **CO**. (See photo on first catalog page.)

VARIATIONS / MODIFICATIONS

- Mixed or special finishes
- Variation in overall height

NOTE: Both the table lamp & floor lamp are available for fixed-base mounting and with or without a switch.

SPEC GUIDE SAMPLE SPEC: 807-TL-14-SAL-BLK-DIM

CAT#	SIZE	LAMP	FINISH	CORD	OPTIONS
<input type="checkbox"/> 807-TL	<input type="checkbox"/> 12	<input type="checkbox"/> CF1/26	<input type="checkbox"/> SAL	<input type="checkbox"/> BLK	<input type="checkbox"/> FAUX
<input type="checkbox"/> 807-FL	<input type="checkbox"/> 14	<input type="checkbox"/> CF1/13	<input type="checkbox"/> SB	<input type="checkbox"/> WHT	<input type="checkbox"/> DIM
	<input type="checkbox"/> 16	<input type="checkbox"/> LED/12	<input type="checkbox"/> AB		<input type="checkbox"/> CO (Conv. Outlet)



Our fixtures are handcrafted here in the USA using the highest quality materials.



999 Montague St • San Leandro, CA 94577 • ph 510.357.0171 • fax 510.357.3832 • www.bordenlighting.com