

**LUMINOUS SCONCE**

Design  
Sustainability  
Value



Shown in Satin Aluminum



print this page



email this page to a colleague



installation instructions



interactive submittal drawing

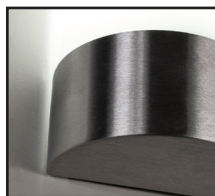

**FEATURES**

- ADA compliant.
- Simple shape complements many architectural styles.

**ECO INFO**

**METALS:** Aluminum parts use highest available recycled content for lower embodied energy. All metals are valuable and recyclable at the end of the product's useful life.

For more information see "GENERAL INFO"

**FINISHING:** Solid, natural metal finishes are sealed with a hand-applied bees wax. No paint or lacquer is used in order to avoid pollution associated with the manufacture and application of these substances. Clear coat finishes are available. Paint finishes are low VOC and oven cured.

**ENERGY:** Designed exclusively for compact fluorescent lamps using HPF electronic ballasts or LEDs.

**MATERIALS**

- Spun aluminum, hand finished.
- Luminous shield is extruded acrylic.

**FINISHES**

**SAL** Satin Aluminum

**MW** Matte White

**CCP** Custom Color Painted finish

Standard metal finishes are hand satined and waxed. Other metal finishes are available. Contact factory.

**LAMPING**

**CF:** 1-CF26W DTT, CF32W or CF42WTTT, Gx24q base. Lamps not included.

**LED:** 1-GU24 base A19, 12W, 1100 lumens, 3000K and triac dimmable. Supplied with fixture.

**BALLAST/DRIVER**

**CF:** Integral electronic HPF, 120V/277V.

**LED:** Electronic driver is built into the lamp, 120V only.



# 514

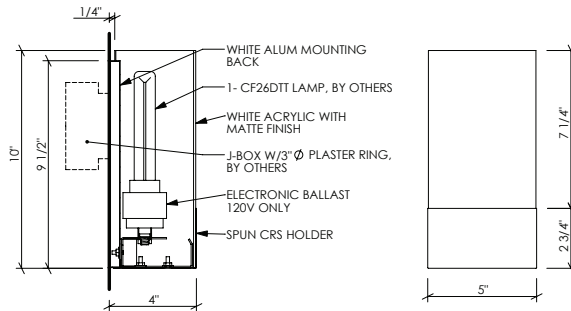

NOTE: FIXTURE REQUIRES 3" Ø PLASTER RING OR SINGLE GANG BOX.

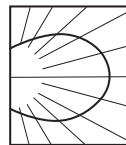

## PHOTOMETRICS

Lighting Sciences Report No. 23668

Fixture efficiency 65.5%

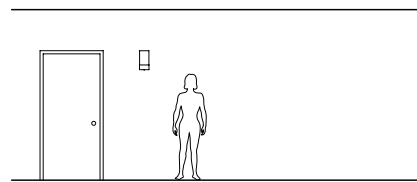

### OPTIONS

**FAUX:** Hand applied faux finish available. Specify **FAUX**.

**DIMMING: CF:** Lutron and Advance dimming ballast available. **LED:** Triac dimmable, 120V only.

**NORMAL POWER FACTOR BALLAST:** This fixture is available with an NPF 120 volt electronic ballast only for 26W lamp at a lower cost. Specify **120NPF**

**EMERGENCY BATTERY PACK:** Remote mounted EBP, specify **REM**. Not available for **LED**.

### VARIATIONS / MODIFICATIONS

- Special finishes
- Addition of decorative detail

**NOTE:** Standard electronic ballast is multi-volt and multi-wattage. Fixture will accommodate 26, 32 or 42 watt lamps.

**MOUNTING: NOTE!** This fixture requires a plaster ring or single gang box.

**WEIGHT:** 3 lbs

## SPEC GUIDE SAMPLE SPEC: 514-CF1/26-120-SAL-FAUX

CAT#	LAMPING	VOLT	FINISH	OPTION
<input type="checkbox"/> 514	<input type="checkbox"/> CF1/26	<input type="checkbox"/> 120	<input type="checkbox"/> SAL	<input type="checkbox"/> FAUX
	<input type="checkbox"/> CF1/32	<input type="checkbox"/> 277	<input type="checkbox"/> MW	<input type="checkbox"/> REM
	<input type="checkbox"/> CF1/42	<input type="checkbox"/> 120NPF	<input type="checkbox"/> CCP	
	<input type="checkbox"/> LED1/12			



Our fixtures are handcrafted here in the USA using the highest quality materials.



999 Montague St • San Leandro, CA 94577 • ph 510.357.0171 • fax 510.357.3832 • www.bordenlighting.com